

TWO STAGE LIGHT OIL BURNERS

► RL SERIES

► RL 28	95/166 ÷ 332 kW
► RL 34 MZ	97/154 ÷ 395 kW
► RL 38	118/237 ÷ 450 kW
► RL 44 MZ	155/235 ÷ 485 kW
► RL 50	148/296 ÷ 593 kW
► RL 64 MZ	200/400 ÷ 820 kW
► RL 70	255/474 ÷ 830 kW
► RL 100	356/711 ÷ 1186 kW
► RL 130	486/948 ÷ 1540 kW
► RL 190	759/1423 ÷ 2443 kW
► RL 250 MZ	600/1250 ÷ 2700 kW

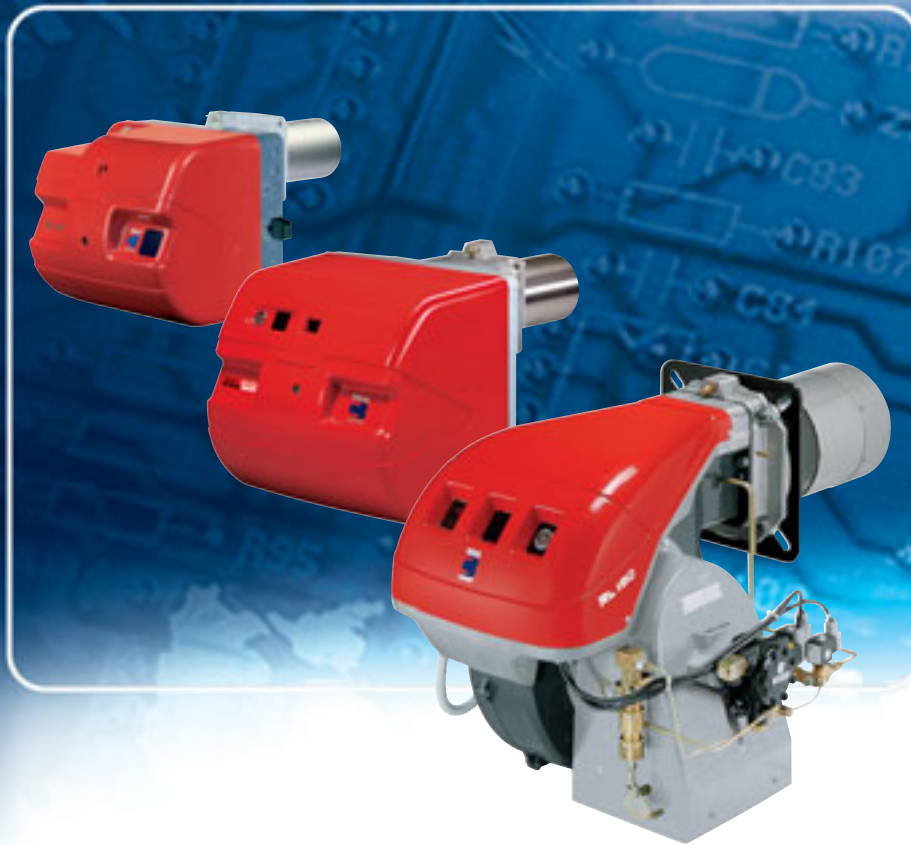

The RL series of burners covers a firing range from 95 to 2700 kW, and it has been designed for use in low or medium temperature hot water boilers, hot air or steam boilers, diathermic oil boilers.

Operation is "two stage"; the burners are fitted with a microprocessor-based control panel, which supplies indication of burner status and fault causes.

Optimisation of sound emissions is guaranteed by the special design of the air suction circuit. The elevated performance of the fans and combustion head, guarantee flexibility of use and excellent working at all firing rates.

The exclusive design ensures reduced dimensions, simple use and maintenance. A wide range of accessories guarantees elevated working flexibility.



TECHNICAL DATA

Model		▼ RL 28	▼ RL 34 MZ	▼ RL 38	▼ RL 44 MZ	▼ RL 50	▼ RL 64 MZ		
Burner operation mode		Two stage							
Modulation ratio to max. output		2 ÷ 1							
Servo-motor	type	--							
	run time	s							
Heat output	kW	95/166÷332	97/154÷395	118/237÷450	155/235÷485	148/296÷593	200/400÷820		
	Mcal/h	82/143÷286	83/133÷340	101/204÷387	133/204÷418	127/255÷510	172/344÷705		
	Kg/h	8/14÷28	8,3/13÷33,6	10/20÷38	13/20÷41	12,5/25÷50	17/38÷69		
Working temperature	°C min./max.	0/40							
Net calorific value	kWh/kg	11,8							
	Kcal/kg	10200							
Viscosity at 20°C	mm ² /s (cSt)	4 ÷ 6							
Pump	type	AN 57C	AN 57C	AL 65C	AN 67C	AL 75C	AL 95C		
	output	kg/h at 12 bar	45	45	67	67	88	107	
Atomised pressure	bar	12							
Oil temperature	Max. °C	50							
Fan	type	(01)	(02)	(01)	(02)	(01)	(02)		
Air temperature	Max. °C	60							
Electrical supply	Ph/Hz/V	(03)	(04)	(03)	(04)	(06)	(09)	(05)	
Auxiliary electrical supply	Ph/Hz/V	(03)	(04)	(03)	(04)	(03)	(03)		
Control box	type	RMO 88.53							
Total electrical power	kW	0,37	0,6	0,6	0,56	0,7	0,75	1,4	
Auxiliary electrical power	kW	0,22	0,3	0,18	0,11	0,28	0,3	0,3	
Protection level	IP	44	2XD	44	2XD	44	44		
Power electric motor	kW	0,25	0,3	0,42	0,45	0,42	0,45	0,65	1,1
Rated motor current	A	2,1	2,4	2,9	2 - 1,2	3	2 - 1,2	3 - 1,7	4,7 - 2,7
Motor start current	A	4,8	9,6	11	9,5 - 5,5	12	9,5 - 5,5	13,8 - 8	24,5 - 14
Motor protection level	IP	54	20	54	44	54	55		
Ignition transformer	V1 - V2	230V - 2x5kV	230V - 2x12kV	230V - 2x5kV	230V - 2x12kV	230V - 2x5kV	230V - 2x5kV		
	I1 - I2	1,9A - 30mA	0,2A - 30mA	1,9A - 30mA	0,2A - 30mA	1,9A - 30mA	1,9A - 30mA		
Operation		(10)	(11)	(10)	(11)	(10)	(11)		
Sound pressure	dBA	68	70	70	72	75	76		
Sound output	W	--							
CO emission	mg/kWh	< 40							
Grade of smoke indicator	N° Bach.	< 1							
C _x H _y emission	mg/kWh	<10 (after the first 20 s.)							
NOx emission	mg/kWh	< 200	< 185	< 200	< 185	< 200	< 185		
Directive		73/23 - 89/336 - 98/37 - 92/42 EEC							
According to		EN 267							
Certification		DIN 5G224/93	CE-0036 0383/07	DIN 5G225/93	CE-0036 0383/07	DIN 5G226/93	CE-0036 0382/07		

- (01) Centrifugal with reverse curve blades
 (02) Centrifugal with forward curve blades
 (03) 1/50/230~(±10%)
 (04) 1/50-60/220-230~(±10%)
 (05) 3N/50/230-400~(±10%) 3/50/230~(±10%)△
 (06) 3N/50-60/220-400~(±10%) 3/50-60/220-230~(±10%)△
 (07) 3N/50/400~(±10%)
 (08) 3N/50/230~(±10%) 3/50/230~(±10%)
 (09) 3N/50/400~(±10%) 3/50/230~(±10%) △
 (10) Intermittent (at least one stop every 24 h)
 (11) Intermittent (at least one stop every 24 h) - Continuous as optional (at least one stop every 72 h)

Reference conditions:

Temperature: 20°C
 Pressure: 1013.5 mbar
 Altitude: 100 m a.s.l.
 Noise measured at a distance of 1 meter.

Since the Company is constantly engaged in the production improvement, the aesthetic and dimensional features, the technical data, the equipment and the accessories can be changed.
 This document contains confidential and proprietary information of RIELLO S.p.A. Unless authorised, this information shall not be divulged, nor duplicated in whole or in part.



Model		▼ RL 70	▼ RL 100	▼ RL 130	▼ RL 190	▼ RL 250 MZ
Burner operation mode		Two stage				
Modulation ratio to max. output		2 ÷ 1				
Servo-motor	type	--				
	run time	s				
Heat output	kW	255/474÷830	356/711÷1186	486/948÷1540	759/1423÷2443	600/1250÷2700
	Mcal/h	219/408÷714	306/612÷1020	418/816÷1325	653/1224÷2100	516/1075÷2322
	Kg/h	21,5/40÷70	30/60÷100	41/80÷130	64/120÷206	51/106÷228
Working temperature	°C min./max.	0/40				
Net calorific value	kWh/kg	11,8				
	Kcal/kg	10200				
Viscosity at 20°C	mm ² /s (cSt)	4 ÷ 6				
Pump	type	AL 95C	AJ 6CC	AJ 6CC	J7C	J7 4PT
	output	kg/h at 12 bar	107	164	164	230
Atomised pressure	bar	12				
Oil temperature	Max. °C	50				
Fan	type	(01)	(01)	(01)	(02)	(02)
Air temperature	Max. °C	60				
Electrical supply	Ph/Hz/V	(09)	(09)	(09)	(09)	(07)
Auxiliary electrical supply	Ph/Hz/V	(03)	(03)	(03)	(03)	(03)
Control box	type	RMO 88.53				
Total electrical power	kW	1,4	1,8	2,6	5,9	7,2
Auxiliary electrical power	kW	0,3	0,3	0,4	1,4	0,6
Protection level	IP	44	44	44	44	54
Power electric motor	kW	1,1	1,5	2,2	4,5	6,6
Rated motor current	A	4,8 - 2,8	5,9 - 3,4	8,8 - 5,1	15,8 - 9,1	14,8 - 8,5
Motor start current	A	25 - 14,6	27,7 - 16	57,2 - 33,2	126 - 73	114 - 66
Motor protection level	IP	54	54	54	54	55
Ignition transformer	V1 - V2	230V - 2x5kV	230V - 2x5kV	230V - 2x5kV	230V - 2x5kV	230V - 2x5kV
	I1 - I2	1,9A - 30mA	1,9A - 30mA	1,9A - 30mA	1,9A - 35mA	1,9A - 35mA
Operation		(10)	(10)	(10)	(10)	(11)
Sound pressure	dBA	75	77	78,5	83,9	83
Sound output	W	--				
CO emission	mg/kWh	< 40				
Grade of smoke indicator	N° Bach.	< 1				
C _x H _y emission	mg/kWh	<10 (after the first 20 s.)				
NO _x emission	mg/kWh	< 200	< 200	< 200	< 200	< 185
Directive		73/23 - 89/336 - 98/37 - 92/42 EEC				
According to		EN 267				
Certification		DIN 5G424/99	DIN 5G425/99	DIN 5G426/99	DIN 5G861/98	in progress

- (01) Centrifugal with reverse curve blades
- (02) Centrifugal with forward curve blades
- (03) 1/50/230~(±10%)
- (04) 1/50-60/220-230~(±10%)
- (05) 3N/50/230-400~(±10%) 3/50/230~(±10%)△
- (06) 3N/50-60/220-400~(±10%) 3/50-60/220-230~(±10%)△
- (07) 3N/50/400~(±10%)
- (08) 3N/50/230~(±10%) 3/50/230~(±10%)
- (09) 3N/50/400~(±10%) 3/50/230~(±10%) △
- (10) Intermittent (at least one stop every 24 h)
- (11) Intermittent (at least one stop every 24 h) - Continuous as optional (at least one stop every 72 h)

Reference conditions:

Temperature: 20°C
 Pressure: 1013.5 mbar
 Altitude: 100 m a.s.l.
 Noise measured at a distance of 1 meter.



FIRING RATES

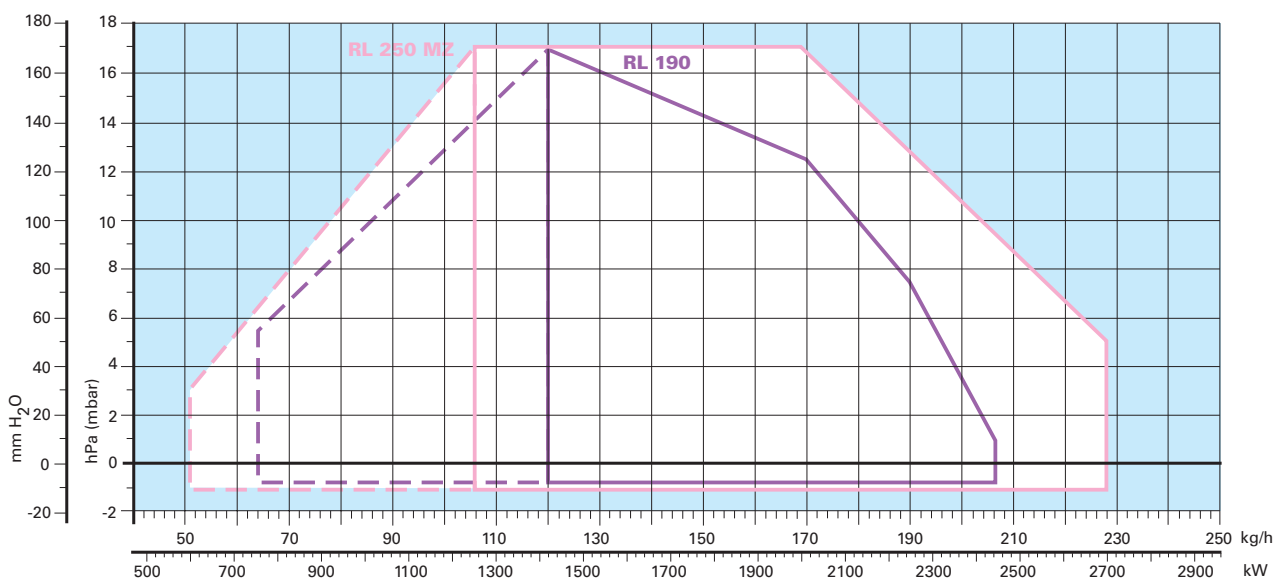
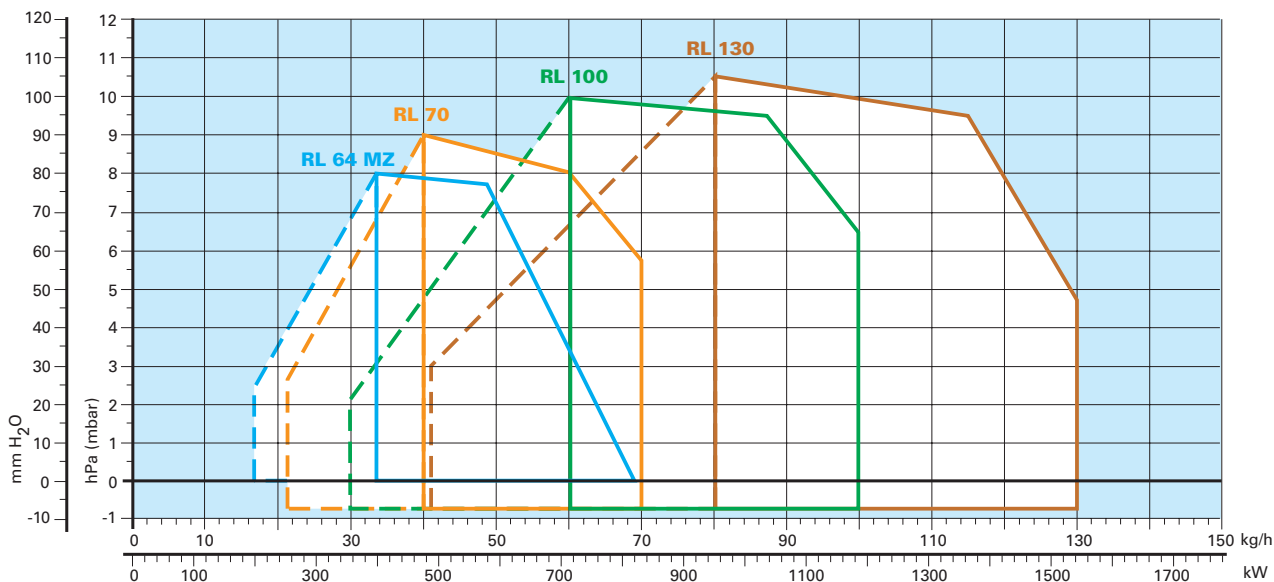
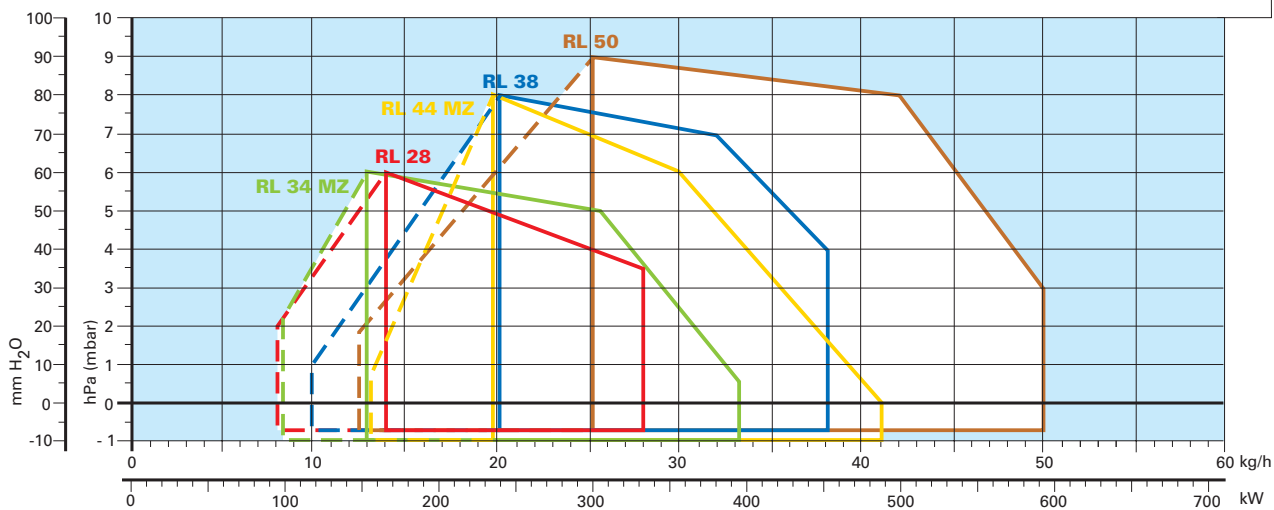

 Useful working field for choosing the burner

 1st stage operating rate

Test conditions conforming to EN 267:

Temperature: 20°C
 Pressure: 1013.5 mbar
 Altitude: 100 m a.s.l.

FUEL SUPPLY

HYDRAULIC CIRCUITS



Example of adjustable hydraulic ram of RL 34 - 44 MZ burners

The burners are fitted with three valves (a safety valve and two oil delivery valves).

A control device, on the basis of required output, regulates oil delivery valves opening, allowing light oil passage through the valves and the nozzle.

Delivery valves opening supplies the two-stage hydraulic ram which regulates air delivery in relation to the fuel burnt. The pumping group is fitted with a pump, an oil filter and a regulating valve, that adjust atomised pressure.

RL 28 - 34 MZ

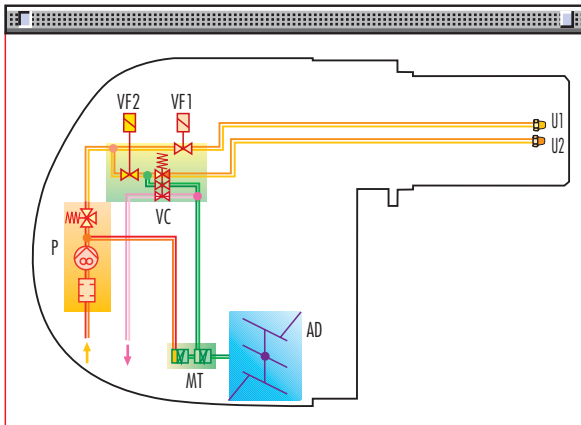

RL 38 - 44 MZ - 50 - 64 MZ

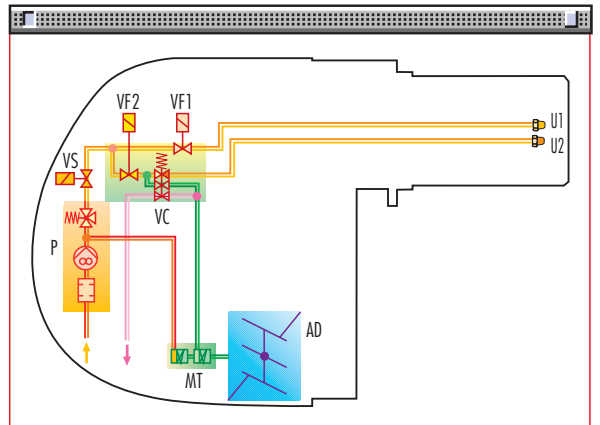

RL 70 - 100 - 130

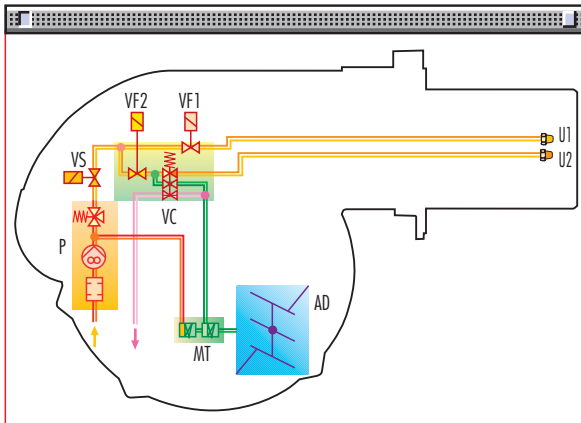

RL 190

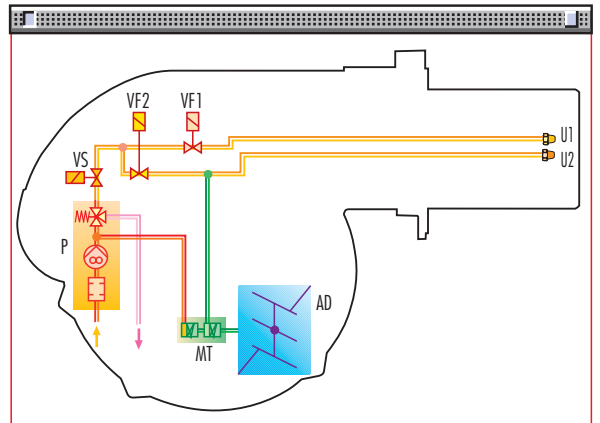

RL 250 MZ

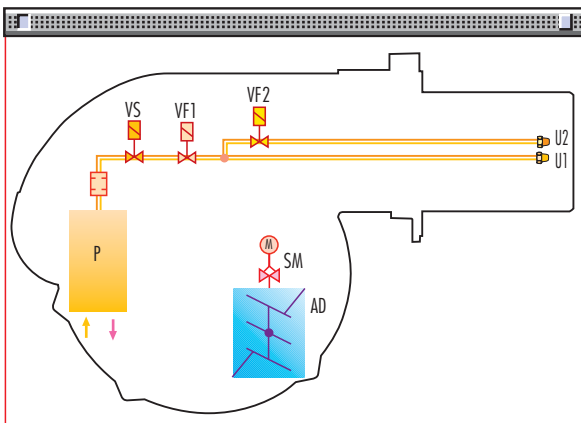

P	Pump with filter and pressure regulator on the output circuit
VS	Safety valve on the output circuit
VF1	1st stage valve
VF2	2nd stage valve
VC	2nd stage control device
MT	Hydraulic ram
AD	Air damper
U1	1st stage nozzle
U2	2nd stage nozzle



DIMENSIONING OF THE FUEL SUPPLY LINES

The fuel feed must be completed with the safety devices required by the local norms.

The table shows the choice of piping diameter for the various burners, depending on the difference in height between the burner and the tank and their distance.

MAXIMUM EQUIVALENT LENGTH FOR THE PIPING L[m]											
Model	▼ RL 28			▼ RL 38 - 50			▼ RL 70 - 100 - 130			▼ RL 190	
Diameter piping	Ø10mm	Ø12mm	Ø14mm	Ø10mm	Ø12mm	Ø14mm	Ø12mm	Ø14mm	Ø16mm	Ø16mm	Ø18mm
+H, -H (m)	L _{max} (m)	L _{max} (m)	L _{max} (m)	L _{max} (m)	L _{max} (m)	L _{max} (m)	L _{max} (m)	L _{max} (m)	L _{max} (m)	L _{max} (m)	L _{max} (m)
+4,0	63	144	150	51	112	150	71	138	150	60	80
+3,0	55	127	150	46	99	150	62	122	150	50	70
+2,0	48	111	150	39	86	150	58	106	150	40	60
+1,5	44	102	150	35	79	147	51	98	150	35	55
+1,0	40	94	150	32	73	144	44	90	150	30	50
+0,5	37	86	150	29	65	132	40	82	150	25	45
0	33	78	150	26	60	120	36	74	137	20	40
-0,5	29	70	133	23	54	106	32	66	123	18	35
-1,0	25	82	118	20	47	96	28	56	109	15	30
-1,5	21	63	103	16	40	83	23	49	95	13	25
-2,0	17	45	88	13	34	71	19	42	81	10	20
-3,0	10	29	58	7	21	46	10	26	53	5	10
-4,0	4	12	28	2	8	21	3	10	25	3	6

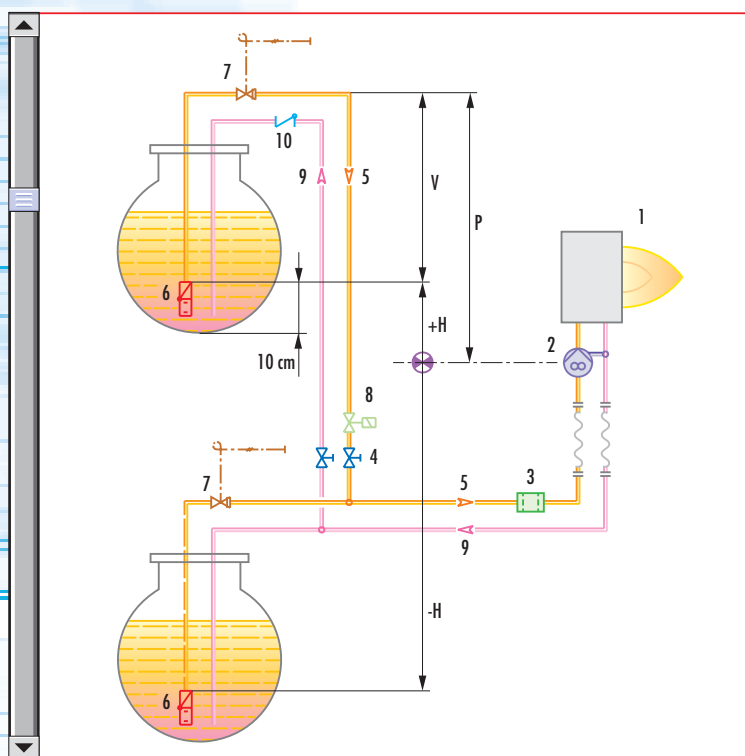

H	Difference in height pump-foot valve
Ø	Internal pipe diameter
P	Height 10 m
V	Height 4 m
1	Burner
2	Burner pump
3	Filter
4	Manual shut off valve
5	Suction pipework
6	Bottom valve
7	Remote controlled rapid manual shut off valve (compulsory in Italy)
8	Type approved shut off solenoid valve (compulsory in Italy)
9	Return pipework
10	Check valve

note With ring distribution oil systems, the feasible drawings and dimensioning are the responsibility of specialised engineering studios, who must check compatibility with the requirements and features of each single installation.

VENTILATION



Example of the air damper on RL 28 - 38 - 50 burners

The ventilation circuit produces low noise levels with high performance pressure and air output, in spite of the compact dimensions.

On RL 28-38-50-100-130 models, the use of reverse curve blades and sound proofing material keeps noise level very low.

In the RL 34 MZ-44 MZ-64 MZ-190-250 MZ models, sound has been reduced by the special design of the air suction circuit.

An hydraulic ram allows to have a right air flow in any operational moment and the closure of the air damper with burner in stand-by.

The RL 34 MZ and RL 44 MZ are realised with a new structure made by an innovative technology based on a new fibreglass reinforced polyamide material, with high thermal and mechanical characteristics, instead of the traditional aluminium.

This allows big advantages in terms of lay-out rationalisation, weight and dimensions reduction.



Example of HCS (Housing Cooling System) working concept

In order to guarantee the correct exercise temperature for the internal burner components in every working conditions, the new structure includes an innovative patented cooling technology.

Between the burner front base and the reinforcing steel front plate, had been create an air cavity offering an high thermal insulation against the front boiler reflection heat, and to further improve the insulation efficiency the innovative **HCS (Housing Cooling System)** technology had been developed. Inside the front base cavity an air circulation is activated with continuous air volume refresh to obtain an active cooling system and avoid any heat transfer to the electrical component housing.

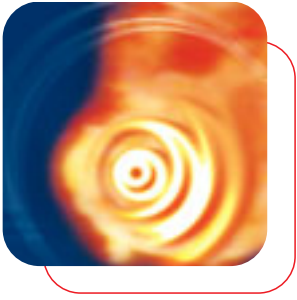

COMBUSTION HEAD

Different lengths of the combustion head can be chosen for the RL series of burners.

The choice depends on the thickness of the front panel and the type of boiler.

Depending on the type of generator, check that the penetration of the head into the combustion chamber is correct.

The internal position of the combustion head can easily be adjusted to the maximum defined output by adjusting a screw fixed to the flange.

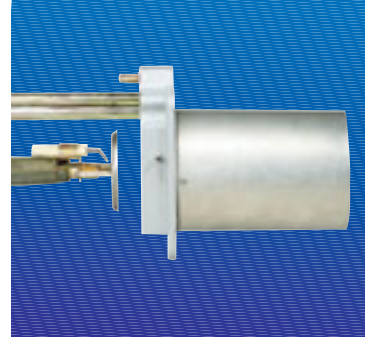

Example of a RL burner combustion head

Dimensions of the flame

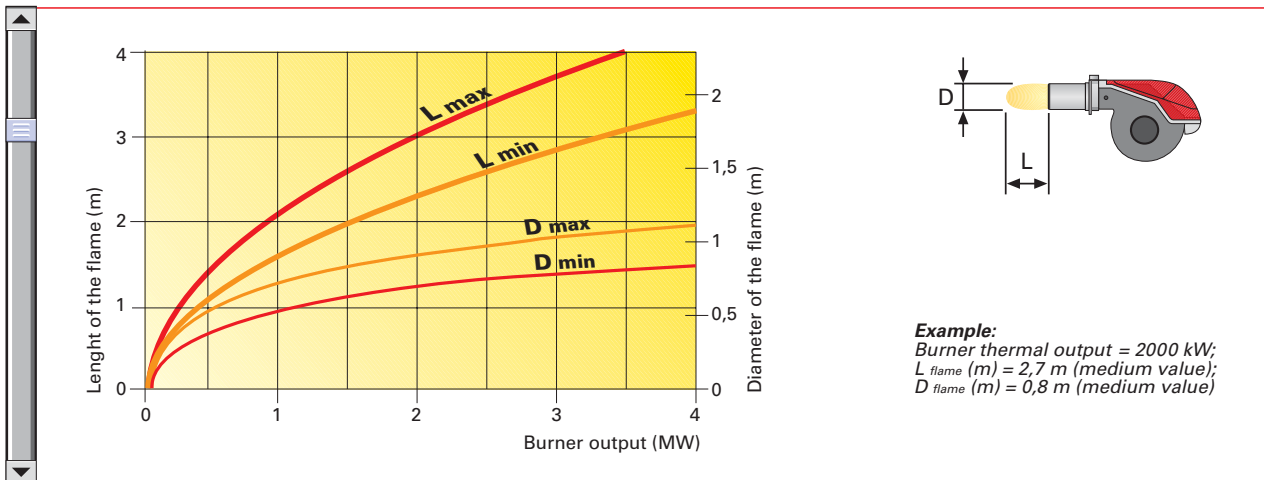

ADJUSTMENT



BURNER OPERATION MODE

Two stage operation

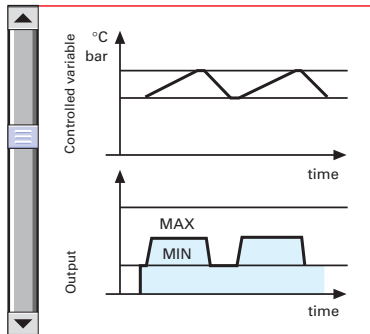



With two stage operation, the RL burners can follow the temperature load requested by the system. A modulation ratio of 2:1 is reached, thanks to the “two nozzles” technique; the air is adapted to the hydraulic ram positions. On “two stage” operation, the burner gradually adjusts output to the requested level, by varying between the two pre-set levels (see picture A).

Picture A

All RL series burners are fitted with a new microprocessor control panel for the supervision during intermittent operation.

For helping the commissioning and maintenance work, there are two main elements:

- 

The lock-out reset button is the central **operating element** for resetting the burner control and for activating / deactivating the diagnostic functions.
- 

The multi-color LED is the central **indication element** for visual diagnosis and interface diagnosis.

Both elements are located under the transparent cover of lock-out reset button, as showed below.

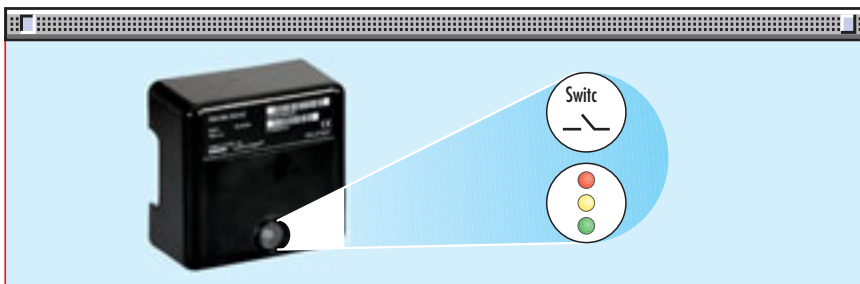

There are two diagnostic choices, for indication of operation and diagnosis of fault cause:
 - **visual diagnosis** :

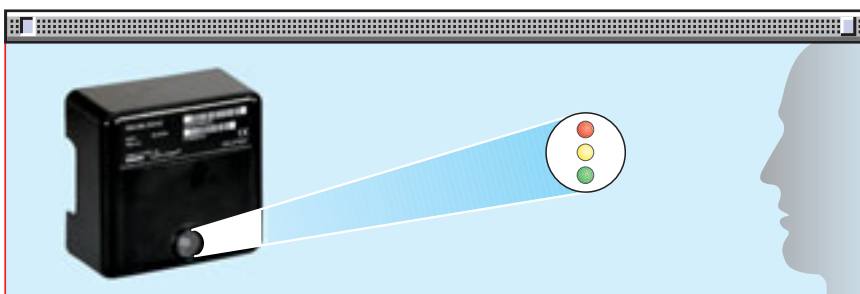

- **interface diagnosis** :



by the interface adapter and a PC with dedicated software or by a predisposed flue gas analyzer (see paragraph accessories).





Indication of operation :

In normal operation, the various status are indicated in the form of colour codes according to the table below.
The interface diagnosis (with adapter) can be activated by pressing the lock-out button for > 3 seconds.

Color code table	
Operation status	Color code table
Stand-by	○ ○ ○ ○ ○ ○ ○ ○
Pre-purging	☀ ☀ ☀ ☀ ☀ ☀ ☀ ☀
Ignition phase	☀ ○ ☀ ○ ☀ ○ ☀ ○
Flame OK	● ● ● ● ● ● ● ●
Poor flame	● ○ ● ○ ● ○ ● ○
Undervoltage, built-in fuse	☀ ☀ ☀ ☀ ☀ ☀ ☀ ☀
Fault, alarm	☀ ☀ ☀ ☀ ☀ ☀ ☀ ☀
Extraneous light	☀ ● ☀ ● ☀ ● ☀ ●

○ LED off

Diagnosis of fault causes :

After lock-out has occurred, the red signal lamp is steady on. In this status, the visual fault diagnosis according to the error code table can be activated by pressing the lock-out reset button for > 3 seconds.
The interface diagnosis (with adapter) can be activated by pressing again the lock-out button for > 3 seconds.

The flashing of red LED are a signal with this sequence :

(e.g. signal with n° 3 flashes – faulty air pressure monitor)

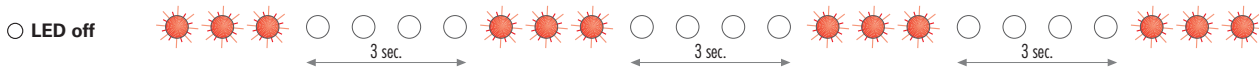

Error code table	
Possible cause of fault	Flash code
No establishment of flame at the end of safety time : - faulty or soiled fuel valves - faulty or soiled flame detector - poor adjustment of burner, no fuel - faulty ignition equipment	2 flashes ☀ ☀
Faulty air pressure monitor	3 flashes ☀ ☀ ☀
Extraneous light or simulation of flame on burner start up	4 flashes ☀ ☀ ☀ ☀
Loss of flame during operation : - faulty or soiled fuel valves - faulty or soiled flame detector - poor adjustment of burner	7 flashes ☀ ☀ ☀ ☀ ☀ ☀ ☀
Wiring error or internal fault	10 flashes ☀ ☀ ☀ ☀ ☀ ☀ ☀ ☀ ☀ ☀

▶ START UP CYCLE

RL 28 - 34 MZ - 38 - 44 MZ - 50 - 64 MZ - 70 - 100 - 130 - 190 - 250 MZ

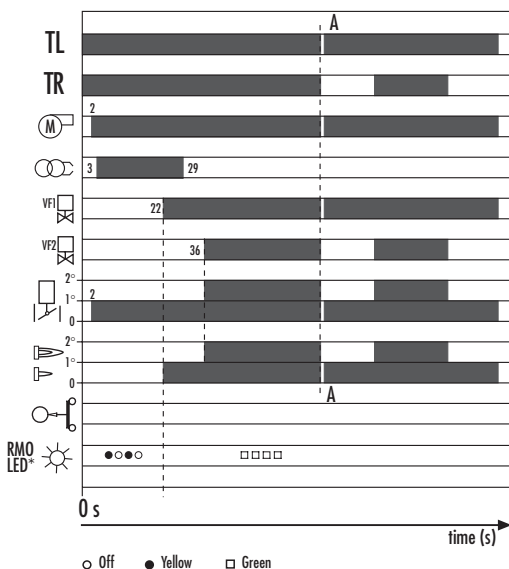

0 s

22÷29 s

36 s

The burner begins the firing cycle: the motor and transformer are supplied; the hydraulic ram opens in the pre-purge position.
Ignition: the VS and VF1 valves are supplied.
If the control device TR is closed or has been replaced by a jumper wire, the 2nd stage valve VF2 opens; the fuel is sprayed out through the 2nd stage nozzle and the hydraulic ram opens the air damper in the 2nd stage position.

BURNER WIRING



Example of the terminal board for electrical connections on RL 28 - 38 burners

All models of the RL burner series have an easily accessible control panel for the electrical components housing and wiring.

In particular the new RL 34-44 MZ models, thanks to the new structure concept, have an extremely clean electrical layout to optimise the commissioning and maintenance speed.

On these models the electrical connections are done by a Plug&Socket system, accessible from the external of the cover.

The electrical wiring of all RL burner models are very easy to do following the wiring diagrams included in the instruction handbook.

Electrical connections must be made by qualified and skilled personnel, according to the local norms.

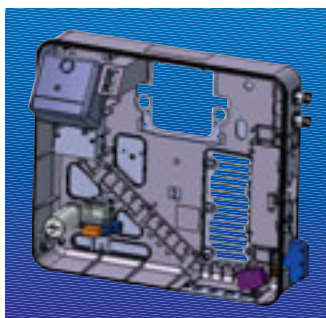

Example of electrical components housing and Plug&Socket system for electrical connection of RL 34 - 44 MZ

The following table shows the supply lead sections and the type of fuse to be used.

Model	▼ RL 28	▼ RL 34 MZ	▼ RL 38		▼ RL 44 MZ	▼ RL 44 MZ		▼ RL 50		▼ RL 64 MZ	
F A	230V T6	230V T6	230V T6	400V T6	230V T6	230V T6	400V T6	230V T6	400V T6	230V T10	400V T6
L mm ²	1,5	1,5	1,5	1,5	1,5	1,5	1,5	1,5	1,5	1,5	1,5

Model	▼ RL 70		▼ RL 100		▼ RL 130		▼ RL 190		▼ RL 250 MZ		
F A	230V T10	400V T6	230V T16	400V T10	230V T16	400V T10	230V T25	400V T25	400V 16A aM - 32A gG		
L mm ²	1,5	1,5	1,5	1,5	1,5	1,5	2,5	2,5	4		



EMISSIONS



NO₂ EMISSIONS

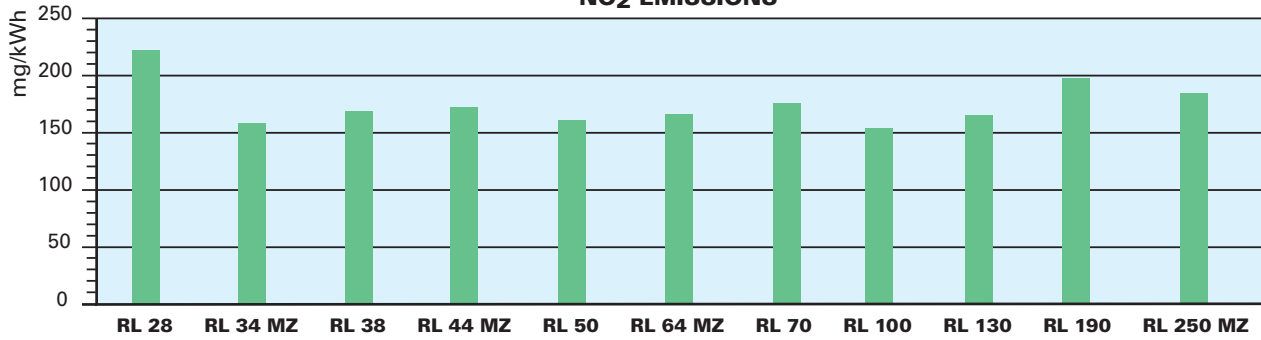

CO EMISSIONS

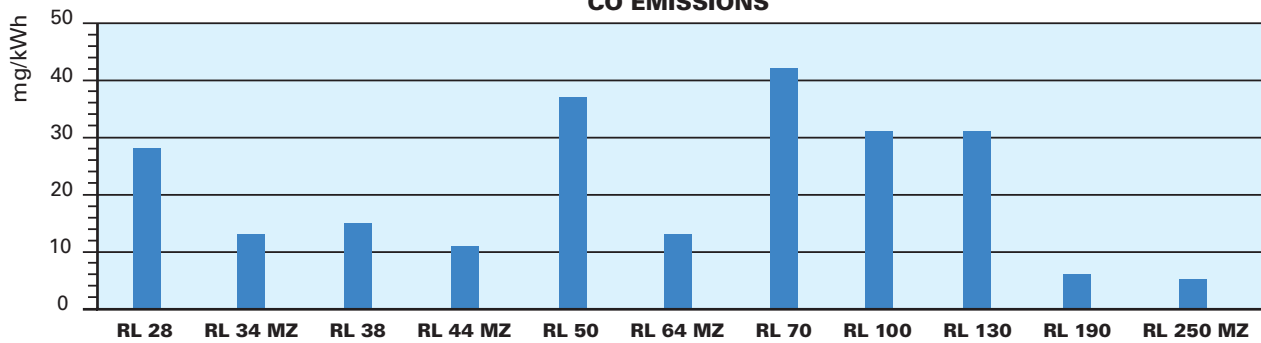

NOISE EMISSIONS

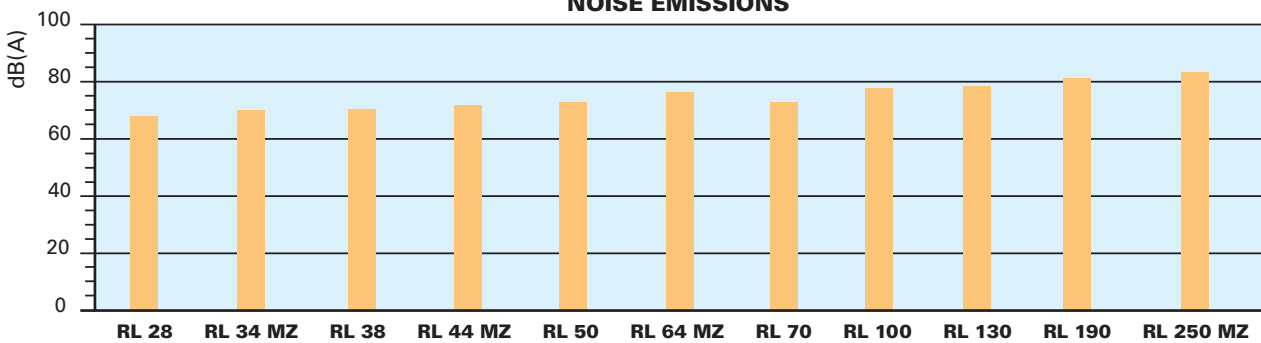

The emission data has been measured in the various models at maximum output, according to EN 267 standard.

The NO_x emissions of RL 34-44-64-250 MZ models are conforming to the class 2 of EN 267.

OVERALL DIMENSIONS (mm)



BURNERS

RL 34 - 44 MZ

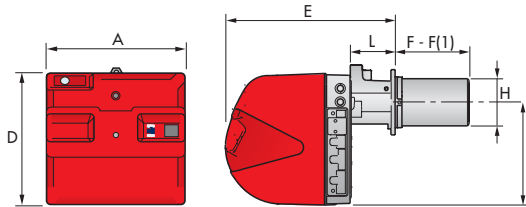

RL 28 - 38 - 50

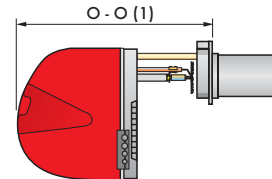
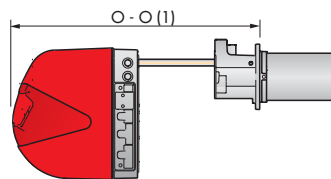
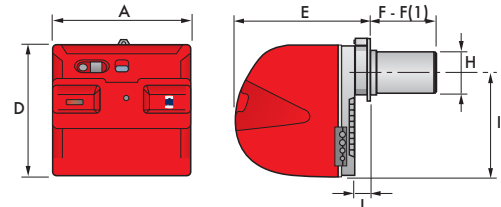

Model	A	D	E	F - F(1)	H	I	L	O - O (1)
▶ RL 28	476	474	468	216 - 351	140	352	52	672 - 807
▶ RL 34 MZ	442	422	508	216 - 351	140	305	138	780 - 915
▶ RL 38	476	474	468	216 - 351	140	352	52	672 - 807
▶ RL 44 MZ	442	422	508	216 - 351	152	305	138	780 - 915
▶ RL 50	476	474	468	216 - 351	152	352	52	672 - 807

(1) Length with extended combustion head

RL 64 MZ

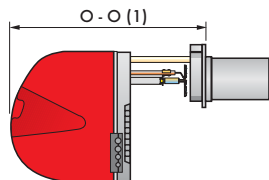
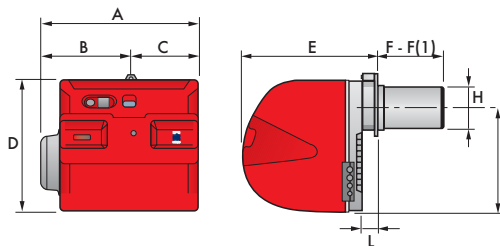

RL 70 - 100 - 130 - 190 - 250 MZ

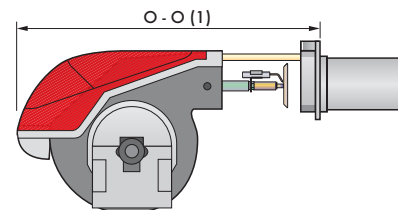
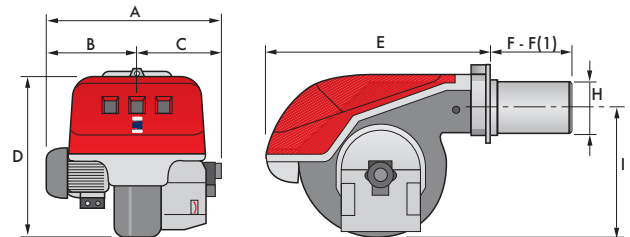

Model	A	B	C	D	E	F - F(1)	H	I	L	O - O (1)
▶ RL 64 MZ	538	300	238	490	477	250 - 385	179	335	60	680 - 545
▶ RL 70	580	296	284	555	680	250 - 385	179	430	-	951 - 1086
▶ RL 100	599	312	287	555	680	250 - 385	179	430	-	951 - 1086
▶ RL 130	625	338	287	555	680	250 - 385	189	430	-	951 - 1086
▶ RL 190	756	366	390	555	696	370 - -	222	430	-	1102 - -
▶ RL 250 MZ	910	432	478	596	705	378 - -	222	436	-	1055 - -

(1) Length with extended combustion head



BURNER - BOILER MOUNTING FLANGE

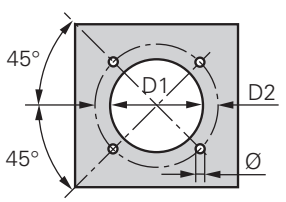

Model	D1	D2	Ø
▶ RL 28	160	224	M8
▶ RL 34 MZ	160	224	M8
▶ RL 38	160	224	M8
▶ RL 44 MZ	160	224	M8
▶ RL 50	160	224	M8
▶ RL 64 MZ	185	275-325	M12
▶ RL 70	185	275-325	M12
▶ RL 100	185	275-325	M12
▶ RL 130	195	275-325	M12
▶ RL 190	230	325-368	M16
▶ RL 250 MZ	230	325-368	M16

PACKAGING

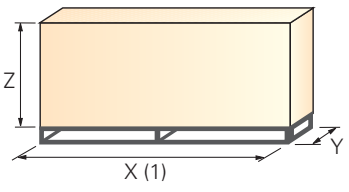

Model	X (1)	Y	Z	kg
▶ RL 28	1200	520	502	36
▶ RL 34 MZ	1010	520	510	32
▶ RL 38	1200	520	502	38
▶ RL 44 MZ	1010	520	510	33
▶ RL 50	1200	520	502	39
▶ RL 64 MZ	1200	560	520	42
▶ RL 70	1410	692	655	60
▶ RL 100	1410	692	655	63
▶ RL 130	1410	692	655	66
▶ RL 190	1410	985	655	75
▶ RL 250 MZ	1410	1040	655	140

(1) Length with short and extended head

INSTALLATION DESCRIPTION

Installation, start up and maintenance must be carried out by qualified and skilled personnel.
All operations must be performed in accordance with the technical handbook supplied with the burner.



BURNER SETTING

- ▶ All the burners have slide bars, for easier installation and maintenance.
- ▶ After drilling the boilerplate, using the supplied gasket as a template, dismantle the blast tube from the burner and fix it to the boiler.
- ▶ Adjust the combustion head.
- ▶ Refit the burner casing to the slide bars.
- ▶ Install the nozzle, choosing this on the basis of the maximum boiler output and following the diagrams included in the burner instruction handbook.
- ▶ Check the position of the electrodes.
- ▶ Close the burner, sliding it up to the flange, keeping it slightly raised to avoid the flame stability disk rubbing against the blast tube.



HYDRAULIC AND ELECTRICAL CONNECTIONS AND START UP

- ▶ The burners are supplied for connection to two pipes fuel supply system.
- ▶ Connect the ends of the flexible pipes to the suction and return pipework using the supplied nipples.
- ▶ Make the electrical connections to the burner following the wiring diagrams included in the instruction handbook.
- ▶ Prime the pump by turning the motor.
- ▶ On start up, check:
 - Pressure pump (to max. and min.)
 - Combustion quality, in terms of unburned substances and excess air.



BURNER MAINTENANCE

- ▶ The maintenance of RL burners is very simple thanks to the sliding bars system that allows an easy access to the internal components.
- ▶ In particular the RL 34-44 MZ models have a new sliding bars system to make easier the access to the combustion head.
- ▶ The RL 190 and RL 250 MZ have new reinforced sliding bars that make very strong the burner structure during maintenance.

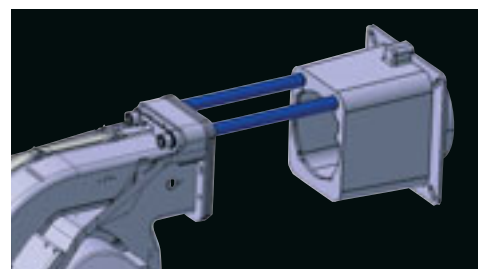



BURNER ACCESSORIES



Nozzles

The nozzles must be ordered separately. The following table shows the features and codes on the basis of the maximum required fuel output.



Nozzles type 60° B					
Burner	GPH	Rated output (kg/h)			Nozzle code
		at 10 bar	at 12 bar	at 14 bar	
RL 34 MZ	1,00	4,1	4,5	4,9	3042077
RL 34 MZ	1,25	4,7	5,2	5,6	3042096
RL 34 - 44 MZ	1,50	5,7	6,3	6,8	3042107
RL 34 - 44 MZ	1,75	6,7	7,3	7,9	3042110
RL 28 - 34 MZ - 44 MZ	2,00	7,7	8,5	9,2	3042126
RL 28 - 34 MZ - 38 - 44 MZ	2,50	9,6	10,6	11,5	3042140
RL 28 - 34 MZ - 38 - 44 MZ - 50	3,00	11,5	12,7	13,8	3042158
RL 28 - 34 MZ - 38 - 44 MZ - 50	3,50	13,5	14,8	16,1	3042162
RL 34 MZ - 38 - 44 MZ - 50 - 64 MZ	4,00	15,4	17	18,4	3042172
RL 34 MZ - 38 - 44 MZ - 50 - 64 MZ	4,50	17,3	19,1	20,7	3042182
RL 38 - 44 MZ - 50 - 64 MZ - 70	5,00	19,2	21,2	23	3042192
RL 44 MZ - 50 - 64 MZ - 70	5,50	21,1	23,3	25,3	3042202
RL 44 MZ - 50 - 64 MZ - 70	6,00	23,1	25,5	27,7	3042212
RL 50 - 64 MZ - 70	6,50	25	27,6	30	3042222
RL 64 MZ - 70 - 100	7,00	26,9	29,7	32,3	3042232
RL 64 MZ - 70 - 100	7,50	28,8	31,8	34,6	3042242
RL 64 MZ - 70 - 100	8,00	30,8	33,9	36,9	3042252
RL 64 MZ - 70 - 100	8,50	32,7	36,1	39,2	3042262
RL 64 MZ - 70 - 100 - 130	9,50	36,5	40,3	43,8	3042282
RL 64 MZ - 70 - 100 - 130 - 190	10,00	38,4	42,4	46,1	3042292
RL 64 MZ - 70 - 100 - 130 - 190	11,00	42,3	46,7	50,7	3042312
RL 64 MZ - 100 - 130 - 190 - 250 MZ	12,00	46,1	50,9	55,3	3042322
RL 64 MZ - 100 - 130 - 190 - 250 MZ	13,00	50	55,1	59,9	3042332
RL 64 MZ - 100 - 130 - 190 - 250 MZ	14,00	53,8	59,4	64,5	3042352
RL 64 MZ - 100 - 130 - 190 - 250 MZ	15,00	57,7	63,6	69,2	3042362
RL 64 MZ - 100 - 130 - 190 - 250 MZ	16,00	61,5	67,9	73,8	3042382
RL 64 MZ - 130 - 190 - 250 MZ	17,00	65,4	72,1	78,4	3042392
RL 130 - 190 - 250 MZ	18,00	69,2	76,4	83	3042412
RL 130 - 190 - 250 MZ	19,00	73	80,6	87,6	3042422
RL 130 - 190 - 250 MZ	20,00	76,9	84,8	92,2	3042442
RL 190 - 250 MZ	22,00	84,6	93,3	101,4	3042462
RL 190 - 250 MZ	24,00	92,2	101,8	110,6	3042472
RL 190 - 250 MZ	26,00	99,9	110,3	119,9	3042482
RL 190 - 250 MZ	28,00	107,6	118,8	129,1	3042492
RL 250 MZ	30,00	110,4	122	132,4	3042502
RL 250 MZ	32,00	117,8	130,1	150,1	3042512
RL 250 MZ	35,00	128,8	142,1	154,5	3042522



Extended heads

"Standard head" burners can be transformed into "extended head" versions, by using the special kit. The kits available for the various burners, giving the original and the extended lengths, are listed below.

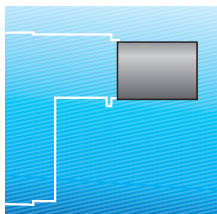

Combustion head extension kits			
Burner	'Standard' head length (mm)	'Extended' head length (mm)	Kit code
RL 28	216	351	3010073
RL 34 MZ	216	351	3010426
RL 38	216	351	3010074
RL 44 MZ	216	351	3010425
RL 50	216	351	3010075
RL 64 MZ	250	385	3010114
RL 70	250	385	3010114
RL 100	250	385	3010115
RL 130	250	385	3010116
RL 190	370	530	3010444
RL 250 MZ	378	528	3010422

Spacer kit

If burner head penetration into the combustion chamber needs reducing, varying thickness spacers are available, as given in the following table:



Head length reduction kit		
Burner	Spacer thickness S (mm)	Kit code
RL 28 - 34 MZ - 38 - 44 MZ - 50	90	3010095
RL 64 MZ - 70 - 100 - 130	135	3010129
RL 190 - 250 MZ	110	3000722

Sound proofing box

If noise emission needs reducing even further, sound-proofing boxes are available, as given in the following table:



Sound proofing box			
Burner	Box type	Average noise reduction [dB(A)](*)	Box code
RL 28 - 34 MZ - 38 - 44 MZ RL 50 - 64 MZ - 70 - 100 - 130	C1/3	10	3010403
RL 190 - 250 MZ	C4/5	10	3010404

(*) according to EN 15036-1 standard



Degasing unit

With single pipe systems, you can find air in the oil sucked by the pump that comes from the oil itself due to negative pressure or to a faulty seal.

To solve this problem, we recommend fitting a degasing unit near the burner. Two versions are available with or without filter:



Degasing unit		
Burner	Degasing unit with filter Code	Degasing unit without filter Code
RL 28 - 34 MZ - 38 RL 44 MZ - 50 - 64 MZ RL 70 - 100 - 130 RL 190 - 250 MZ	3010055	3010054

Biodiesel kit

For burning Biodiesel fuel, a special kit is available.



Biodiesel kit	
Burner	Kit code
RL 28	3010289
RL 38	3010290
RL 50	3010291
RL 70	3010292
RL 100	3010358
RL 130	3010358
RL 190	-

Connection flange kit

A kit is available for use where the burner opening on the boiler is of excessive diameter.

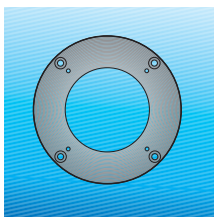

Connection flange kit	
Burner	Kit code
RL 28 - 34 MZ - 38 - 44 MZ - 50	3010138

Status Panel kit

The RL burners can be equipped with an exclusive electronic device "Status Panel" which continuously monitors and displays all the burner operational modes and picks up any anomalies during the operational cycle.



Status Panel kit	
Burner	Kit code
RL 28 - 38 - 50 - 70 - 100 - 130 - 190 - 250 MZ	3010322
RL 64 MZ	3010321



Volt free contact kit

A volt free contact kit is available for installation onto the burner. This can be used for a remote interface between burner operating signals, for example, burner run or lockout indication.



Volt free contact kit	
Burner	Kit code
RL 34 MZ - 44 MZ	3010419

PC interface kit

To connect the flame control panel to a personal computer for the transmission of operation, fault signals and detailed service information, an interface adapter with PC software are available.

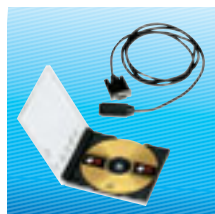

PC interface kit	
Burner	Kit code
RL 28 - 34 MZ - 38 - 44 MZ - 50 - 64 MZ RL 70 - 100 - 130 - 190 - 250 MZ	3002719



SPECIFICATION

A specific index guides your choice of burner from the various models available in the RL series. Below is a clear and detailed specification description of the product.

DESIGNATION OF SERIES R BURNERS

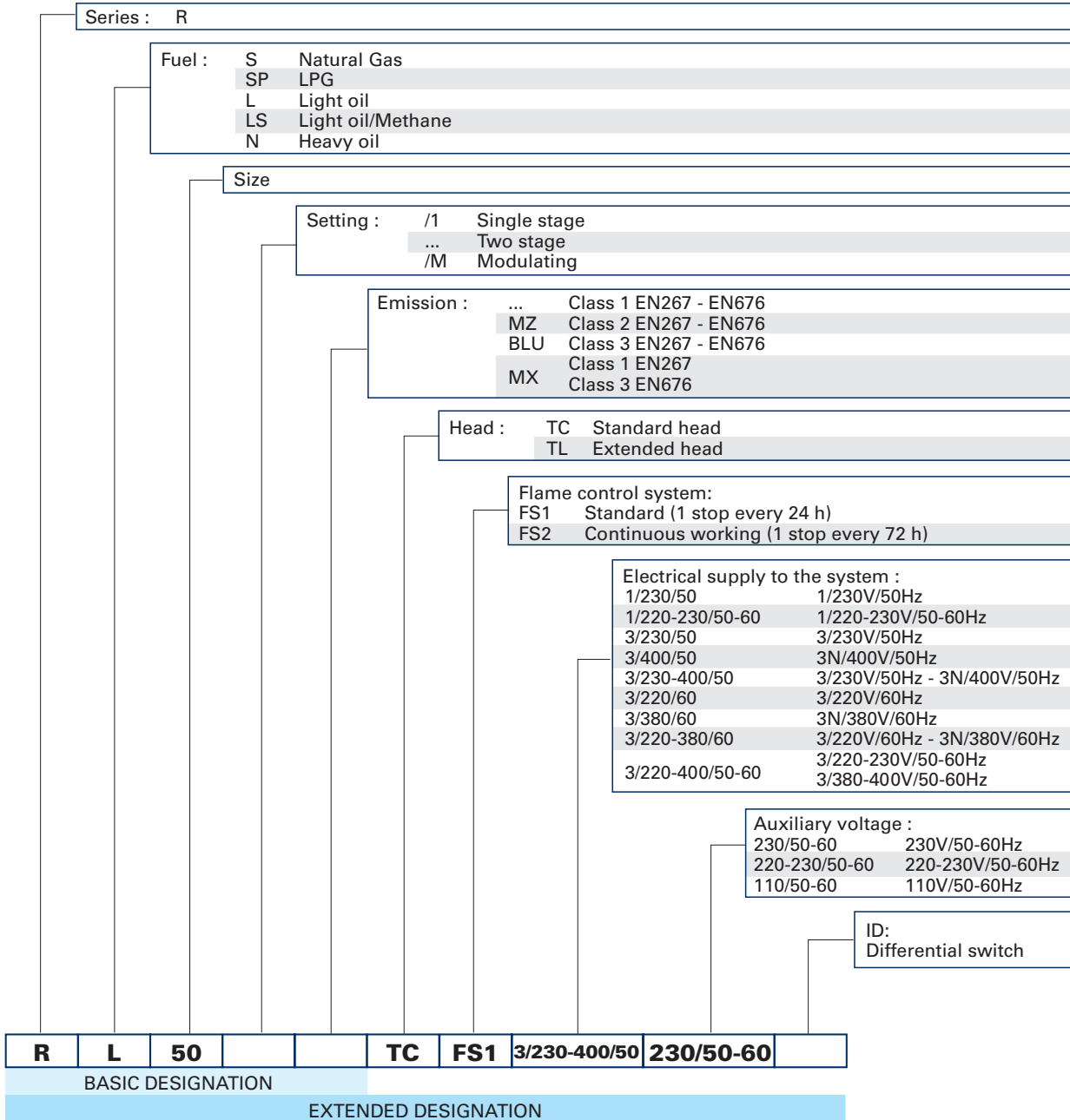



▶ LIST OF AVAILABLE MODELS

RL 28	TC	FS1	1/230/50	230/50-60
RL 28	TL	FS1	1/230/50	230/50-60
RL 28	TC	FS1	1/230/50	230/50-60
RL 28	TL	FS1	1/230/50	230/50-60
RL 28	TC	FS1	1/220-230/60	230/50-60
RL 28	TL	FS1	1/220-230/60	230/50-60
RL 34 MZ	TC	FS1	1/220-230/50/60	220-230/50-60
RL 34 MZ	TL	FS1	1/220-230/50/60	220-230/50-60
RL 38	TC	FS1	1/230/50	230/50-60
RL 38	TL	FS1	1/230/50	230/50-60
RL 38	TC	FS1	1/230/50	230/50-60
RL 38	TL	FS1	1/230/50	230/50-60
RL 38	TC	FS1	1/220/230/60	230/50-60
RL 38	TL	FS1	1/200/230/60	230/50-60
RL 38	TC	FS1	3/230/400/50	230/50-60
RL 38	TL	FS1	3/230/400/50	230/50-60
RL 38	TC	FS1	3/230/400/50	230/50-60
RL 38	TL	FS1	3/230/400/50	230/50-60
RL 38	TC	FS1	3/220-230/380-400/60	230/50-60
RL 38	TL	FS1	3/220-230/380-400/60	230/50-60
RL 38	TC	FS1	3/254-265/440-460/60	230/50-60
RL 38	TL	FS1	3/254-265/440-460/60	230/50-60
RL 44 MZ	TC	FS1	1/220-230/50/60	220-230/50-60
RL 44 MZ	TL	FS1	1/220-230/50/60	220-230/50-60
RL 44 MZ	TC	FS1	3/220-400/50/60	220-230/50-60
RL 44 MZ	TL	FS1	3/220-400/50/60	220-230/50-60
RL 50	TC	FS1	3/230-400/50	230/50-60
RL 50	TL	FS1	3/230-400/50	230/50-60
RL 50	TC	FS1	3/230-400/50	230/50-60
RL 50	TL	FS1	3/230-400/50	230/50-60
RL 50	TC	FS1	3/220-230/380-400/60	230/50-60
RL 50	TL	FS1	3/220-230/380-400/60	230/50-60
RL 50	TC	FS1	3/254-265/440-460/60	230/50-60
RL 50	TL	FS1	3/254-265/440-460/60	230/50-60
RL 64 MZ	TC	FS1	3/230-400/50	230/50-60
RL 64 MZ	TL	FS1	3/230-400/50	230/50-60
RL 70	TC	FS1	3/230-400/50	230/50-60
RL 70	TL	FS1	3/230-400/50	230/50-60
RL 70	TC	FS1	3/230-400/50	230/50-60
RL 70	TL	FS1	3/230-400/50	230/50-60
RL 70	TC	FS1	3/220-230/380-400/60	230/50-60
RL 70	TL	FS1	3/220-230/380-400/60	230/50-60
RL 70	TC	FS1	3/254-265/440-460/60	230/50-60
RL 70	TL	FS1	3/254-265/440-460/60	230/50-60
RL 100	TC	FS1	3/230-400/50	230/50-60
RL 100	TL	FS1	3/230-400/50	230/50-60
RL 100	TC	FS1	3/230-400/50	230/50-60
RL 100	TL	FS1	3/230-400/50	230/50-60
RL 100	TC	FS1	3/220-230/380-400/60	230/50-60
RL 100	TL	FS1	3/220-230/380-400/60	230/50-60
RL 100	TC	FS1	3/254-265/440-460/60	230/50-60
RL 100	TL	FS1	3/254-265/440-460/60	230/50-60
RL 130	TC	FS1	3/230-400/50	230/50-60
RL 130	TL	FS1	3/230-400/50	230/50-60
RL 130	TC	FS1	3/230-400/50	230/50-60
RL 130	TL	FS1	3/230-400/50	230/50-60
RL 130	TC	FS1	3/220-230/380-400/60	230/50-60
RL 130	TL	FS1	3/220-230/380-400/60	230/50-60
RL 130	TC	FS1	3/254-265/440-460/60	230/50-60
RL 130	TL	FS1	3/254-265/440-460/60	230/50-60
RL 190	TC	FS1	3/230-400/50	230/50-60
RL 190	TC	FS1	3/220-230/380-400/60	230/50-60
RL 190	TC	FS1	3/254-265/440-460/60	230/50-60
RL 250 MZ	TC	FS1	3/400/50	230/50-60

Other versions are available on request.



▶ PRODUCT SPECIFICATION

RL 28 - 38 - 50 - 64 MZ - 70 - 100 - 130 - 190 - 250 MZ models

Burner:

Monoblock forced draught oil burner with two stage operation, fully automatic, made up of:

- Air suction circuit lined with sound-proofing material
- Fan with reverse curve blades (RL 28 - 38 - 50 - 70 - 100 - 130 models) or straight blades (RL 64 MZ - 190 - 250 MZ models)
- Air damper for air setting controlled by an adjustable hydraulic ram (or by a servomotor for the RL 250 MZ)
- Starting motor at 2800 rpm, three-phase 400V with neutral, 50Hz (single-phase, 230V and 50Hz for the 28 - 38 models)
- Combustion head, that can be set on the basis of required output, fitted with:
 - stainless steel end cone, resistant to corrosion and high temperatures
 - ignition electrodes
 - flame stability disk
- Gears pump for high pressure fuel supply, fitted with:
 - filter
 - pressure regulator
 - connections for installing a pressure gauge and vacuumeter
 - internal by-pass for single pipe installation
- Valve unit with an oil safety valve and two delivery oil valves on the output circuit
- Photocell for flame detection
- Microprocessor-based flame control panel, with diagnostic function
- Burner on/off switch
- Flame inspection window
- 1st - 2nd stage manual switch
- Slide bars for easier installation and maintenance
- Protection filter against radio interference
- IP 44 electric protection level.

Conforming to:

- 89/336/EEC directive (electromagnetic compatibility)
- 73/23/EEC directive (low voltage)
- 92/42/EEC directive (performance)
- 98/37/EEC directive (machinery)
- EN 267 (liquid fuel burners).

Standard equipment:

- 2 flexible pipes for connection to the oil supply network
- 2 gaskets for the flexible pipes
- 2 nipples for connection to the pump
- 4 screws for fixing the burner flange to the boiler
- 1 thermal screen
- Fairleads for electrical connections (RL 28 - 38 - 50 models)
- 2 slide bar extensions (for the extended head models and the RL 190 - 250 MZ models)
- Instruction handbook for installation, use and maintenance
- Spare parts catalogue.

Available accessories to be ordered separately:

- Nozzles
- Head extension kit
- Head length reduction kit
- Sound-proofing box
- Degasing unit (with or without filter)
- Biodiesel kit
- Connection flange kit
- Status panel kit
- PC interface kit.



▶ PRODUCT SPECIFICATION

RL 34 MZ - 44 MZ models

Burner:

Monoblock forced draught oil burner with two stage operation, fully automatic, made up of:

- Air suction circuit
- High performance fan with straight blades
- Air damper for air setting controlled by an adjustable hydraulic ram
- Starting motor at 2800 rpm, single-phase / 220-230V / 50-60Hz or three-phase 380-400V / 50-60Hz
- Combustion head, that can be set on the basis of required output, fitted with:
 - stainless steel end cone, resistant to corrosion and high temperatures
 - ignition electrodes
 - flame stability disk
- Exclusive patented HCS (Housing Cooling System) with high thermal insulation and air circulation with continuous air volume refresh for an active cooling system and avoid heat transfer to the electrical component housing
- Gears pump for high pressure fuel supply, fitted with:
 - filter
 - pressure regulator
 - connections for installing a pressure gauge and vacuumeter
 - internal by-pass for single pipe installation
- Valve unit with an oil safety valve and two delivery oil valves on the output circuit
- Photocell for flame detection
- Microprocessor-based flame control panel, with diagnostic function
- Plugs and Sockets for electrical connection, accessible from the external of the cover
- Burner on/off switch
- Flame inspection window
- 1st - 2nd stage manual switch
- Slide bars for easier installation and maintenance
- Protection filter against radio interference
- IP 44 electric protection level.

Conforming to:

- 89/336/EEC directive (electromagnetic compatibility)
- 73/23/EEC directive (low voltage)
- 92/42/EEC directive (performance)
- 98/37/EEC directive (machinery)
- EN 267 (liquid fuel burners).

Standard equipment:

- 2 flexible pipes for connection to the oil supply network
- 2 gaskets for the flexible pipes
- 2 nipples for connection to the pump
- 4 screws for fixing the burner flange to the boiler
- 1 thermal screen
- 2 Plugs for electrical connection (RL 34-44 MZ single-phase)
- 3 Plugs for electrical connection (RL 44 MZ three-phase)
- 2 slide bar extensions (for the extended head models)
- Instruction handbook for installation, use and maintenance
- Spare parts catalogue.

Available accessories to be ordered separately:

- Nozzles
- Head extension kit
- Head length reduction kit
- Sound-proofing box
- Degasing unit (with or without filter)
- Biodiesel kit
- Connection flange kit
- Status panel kit
- Volt free contact kit
- PC interface kit.



RIELLO S.p.A. - Via Ing. Pilade Riello, 5 - 37045 Legnago (VR) Italy
Tel. ++39.0442630111 - Fax ++39.044221980

Internet: <http://www.rielloburners.com> - E-mail: info@rielloburners.com

Since the Company is constantly engaged in the production improvement, the aesthetic and dimensional features, the technical data, the equipment and the accessories can be changed.
This document contains confidential and proprietary information of RIELLO S.p.A.
Unless authorised, this information shall not be divulged, nor duplicated in whole or in part.

